

Please participate & help to  
keep our community clean ★

Welcome to the

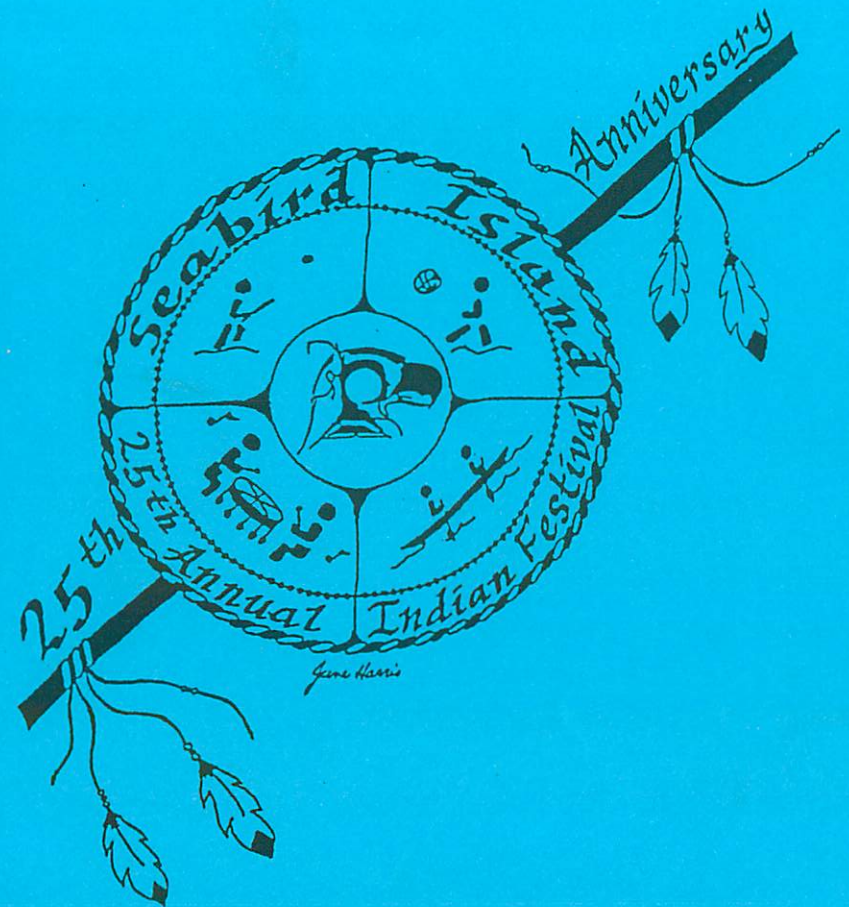

May 27, 28, & 29, 1994

\$1.00ea



## ☞ Welcome ☜

In celebration to our 25th Anniversary of the Seabird Island Festival, a special logo was designed by June Harris, a Seabird Island Member. This logo will be used for our program, T-shirts, sweatshirts, sales.

We have added a couple of attractions to our schedule of events:

Traditional Pow Wow - Saturday & Sunday  
Drop in Bingo - Saturday & Sunday

Also the other scheduled & popular events are:

War Canoe Races  
Youth Co-ed, Mens & Womens Soccer Tournament  
Mixed Two Pitch

As a caution to drivers & parents, there will be children playing along the roadsides. Please slow down & be mindful, we don't want to see any accidents.

Keep in mind, this is an alcohol & drug free event. Be proud of yourself if you're drug free, for just one weekend.

Wishing the best of LUCK to all the competition. Many thanks to our sponsors and volunteers for making our Festival a great success.

Yours in Brotherhood,  
Chief Archie Charles

## Seabird Island Festival

### SCHEDULE OF EVENTS

Canoe Races	☞	Saturday	- 12:00pm	
		Sunday	- 11:00am	
Pow Wow	☞	Saturday	- 1pm - 5pm / 7pm - 12am	
		Sunday	- 1pm - 5pm	
Two Pitch	☞	Friday	- 6:30pm	
		Saturday & Sunday	- 8:00am	
Soccer	☞	Saturday & Sunday	- 8:00am	
Bingo	☞	Saturday & Sunday	- 1:00pm - 4:00pm	
Dance	☞	Saturday	- 8:00pm - 12:00pm	
Concession	☞	6:45 - 10:30am	Breakfast	
		10:30 - 6:00pm	Lunch/Dinner	
Barbecue	☞	12:00 Noon	Each Day	
Arts & Crafts	☞	8:00am		
Church Concession	☞	Firehall	- Saturday & Sunday	
School Concession	☞	Friday	7:00pm - 10:00pm	
		Saturday	9:00am - 8:00pm	
		Sunday	9:00am - 5:00pm	
First Aid	☞	Little Church Hall; Building #2	- St. John's	
Mass	☞	Sunday	12:00 Noon	
Playground	☞	Supervised Until Dusk;	Prohibited After	

## CONCESSION STAND PRICE LISTS

### Main Stand

Pop	1.00	Coffee	.75
Gum	1.00	Chips	1.00
Candy Bars	1.00	Corn	1.50
Hot Dogs	1.00	French Fries	1.50
Plain Burger	2.50	Cheeseburger	3.00
Dlx. Burger	3.00	Dlx. Cheese	3.50
Cigarettes	5.00		

### Church Stand

Chilli	2.00	Bannock	1.00
Coffee & Tea	.50	Pop	1.00

### School Stand

Hot Dog	1.00	Pizza	2.00
Pizza Pops	1.50	Bannock	1.00
Donuts	.50	Cakes/Bars	.75
Popsicles	.50	Chocolate Bar	.75
Chips	1.00	Lg. Ice Tea	1.50
Sm. Drinks	.75	Med. Drinks	1.00
Pop	1.00	Coffee	.50
Spaghetti Special; Served from 11am - 2pm			3.00

### Bar-B-Q Salmon Pit

Dinner	6.00	Pc. Salmon	3.50
Pop	1.00	Cigarettes	5.00

### PROGRAM DRAW

Will be drawn at the Sunday Presentations.  
Drop off at the Grand Stand.

Name: \_\_\_\_\_

Address: \_\_\_\_\_

Tele. No. \_\_\_\_\_

We would also like to thank the following for contributing to our Festival.

Greenline Golf & Turf Equipment  
Canyon Carpets  
Agassiz Ready Mix Concrete & Gravel Ltd.  
Burden Propane  
Unrah's TV  
Key Welding  
Salish Disposal  
Cooper & Associates  
Northwest Hydraulic Consultants Ltd.  
Hardy's Holdings  
L & M Mini Mar  
Esso - Hwy # 7&9  
Harvest Market - Hwy #7  
Harrison Lake Market  
Canadian Linen  
Coast Office Equipment





factory  
built  
portable  
and  
modular  
buildings

**WES WINGER**  
Quality Assurance Manager

Agassiz: (604) 796-2257  
Fax: (604) 796-3755

1825 Tower Road, Agassiz, B.C. V0M 1A0

# britco



Stellaquo - Near Fraser Lake

## 888-2000

Fax: 888-2086

- Factory Built & Portable
- Standard & Custom Plans
- Complete Design Services
- Cost Effective & Quality Product
- Offices, Health Clinics, Housing, Schools & Classrooms

# PETERS'

## ELECTRIC



- Certified Contractor
- Registration #10501 • Serving The Area Since 1975

"A"  
Licensed

## 796-9292

Harold &  
Lorraine Peters

### Mens Soccer Entries

**Xenichen Eagles**  
**Friendly Mikes**  
**Chehalis Chiefs**  
**Coyotes**  
**Stl'Atl'imx**  
**Golden Eagles**

**Kilgard**  
**Stallions**  
**Musqueam Blues**  
**Musqueam Raiders**  
**Fountain**  
**Seabird**

### Womens Soccer Entries

**Musqueam Blues**  
**Burrard**  
**Sechelt**

**Rainbow Stars**  
**Ravens**

### 10 & Under Entries

**Ft. Langley**  
**Sechelt**  
**Jr. Chiefs**

**Chawathil**  
**Seabird**

### 11 - 13 Youth Entries

**Seabird**  
**Chawathil**  
**Mt. Currie**

**Hawks**  
**Takaya Cubs**  
**Musqueam**

### 14 - 16 Youth Entries

**Sto: Lo Braves**  
**Musqueam**

**Lillooet**  
**Sechelt**

Mens Soccer Schedule

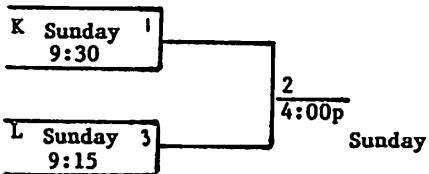
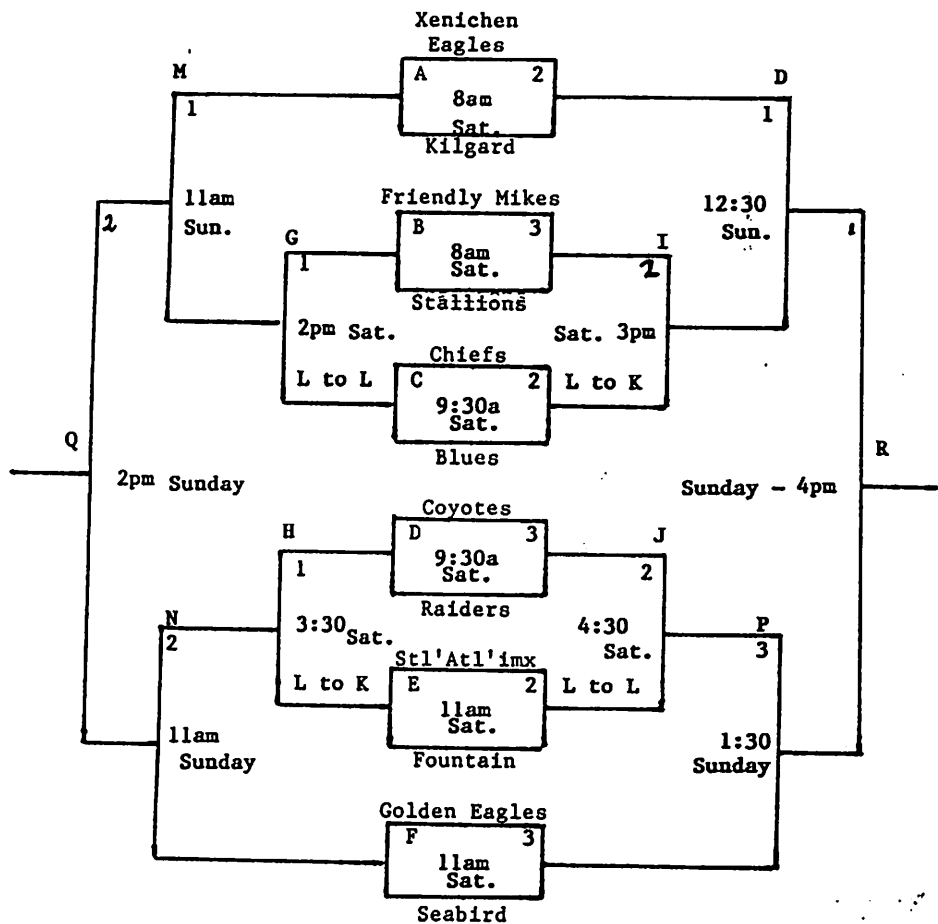

Half Your Money Back

CLIFF PETTIS



SEABIRD CATTLE

P.O. Box 650  
Agassiz, B.C V0M 1A0

Ph: (604) 796-2589  
Fax (604) 796-3729

SUPPLIER OF HAMBURGER  
PATTIES FOR THE FESTIVAL  
AND MAJORITY OF MEATS  
FOR SEABIRD CAFE, WE  
ALSO SELL VARIETY PACKS  
WHOLE OR BY THE SIDES

Richmond (604) 270-4457  
Fax (604) 270-6023  
Saanichton (604) 652-7765

Newhaven Group

Newhaven Projects Ltd. and Newhaven Construction Ltd.

General Contractors and Construction Managers  
239 - 7080 River Road, Richmond, B.C. V6X 1X5  
100 - 7816 Scohon Road, Saanichton, B.C. V0S 1M0



PATHFINDER MOTEL & R.V. PARK

- KITCHENETTES • COLOR T.V. •
- QUEEN SIZE BEDS • CAMPING FACILITIES •



Just minutes from Harrison Hot Springs on No. 7 Hwy.

6110 Loughhead Hwy.  
Agassiz, B.C. V0M 1A0

Phone/Fax (604) 796-9345



YOUR TROY BUILT DEALER  
 YOUR ALL WINNERS IN  
 ONE WAY OR ANOTHER  
 FROM

Womens Soccer Schedule

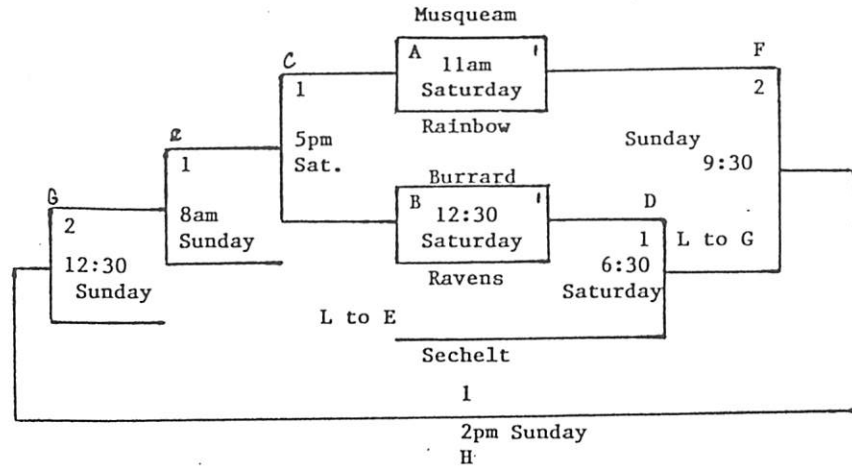

10 & Under Soccer Schedule

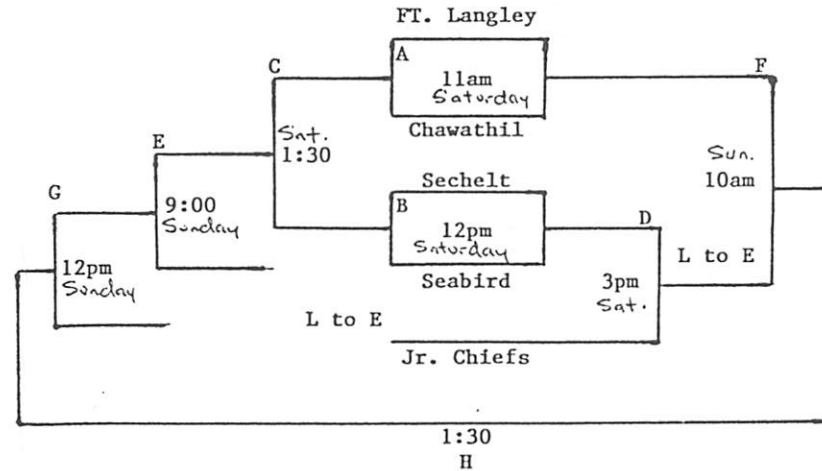

**VALLEY EQUIPMENT LTD.**   
 44725 YALE ROAD WEST  
 CHILLIWACK, B.C. V2P 6H7  
**FORD**  
**NEW HOLLAND**



**RON KITT**  
 Sales Manager

Business 792-1301  
 Abbotsford 853-9474

Fax 792-6880

**B.C. ABORIGINAL NETWORK  
 ON DISABILITY SOCIETY**



"To Promote the betterment of Aboriginal People  
 with Disabilities in the Province of British Columbia."

*Sue Gabriel*  
 796-0083

#17-1529 Cooper Road, Victoria, B.C. V9A 7A6  
 Tel: (604) 384-3144 • Fax: (604) 380-1903

**Royal Canadian Mounted Police**

Agassiz Detachment



**V.M. (Vern) Genaille**  
 Constable  
 Aboriginal Policing

Box 349  
 6869 Lougheed Hwy.  
 Agassiz, B.C. V0M 1A0



11 - 13 Youth Soccer Schedule

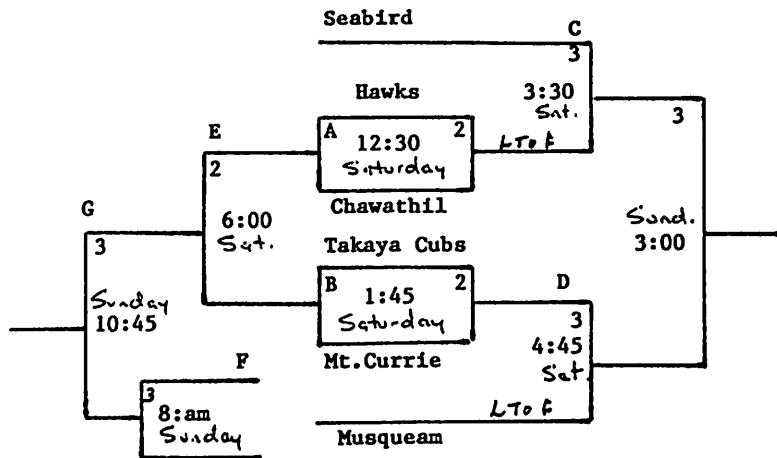

14 - 16 Youth Soccer Schedule

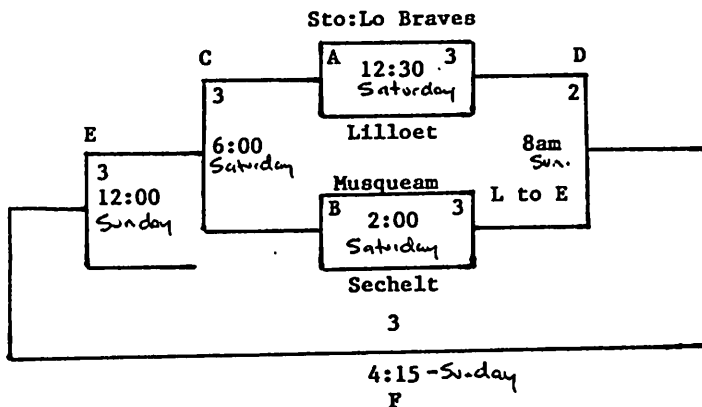

Phone 796-9454

**DAKA CONTRACTING**



- TRACK EXCAVATOR
- BULLDOZING
- TRUCKING

**D.G. HASTIE**

P.O. Box 296, Agassiz, B.C. V0M 1A0

TELEPHONE (604) 684-8000  
TELECOPIER (604) 684-8008

**W. Graham Allen**  
Barrister and Solicitor

**Snarch & Allen**  
Barristers & Solicitors

907-1030 W. Georgia St.  
Vancouver, B.C. V6E 2Y3

**RUDI'S SPORTS**  
"Your Sports Connection"

**RUDY LEON**

7236 Pioneer Ave.  
P.O. Box 413  
Agassiz, B.C. V0M 1A0

796-9156  
Res. 796-2800  
Fax 796-9136



Agassiz (604) 796-2131  
Chilliwack 792-3424  
Hope (No Toll) 869-5040  
Fax 796-3838

**LEDoux**  
**HARDWARE & SUPPLY LTD.**

Hardware — Plumbing — Electrical — Paint — Giftware  
Farm Supplies — Water Pressure & Treatment Systems  
Ingils — Kelvinator & Small Appliances  
EQUIPMENT RENTAL SALES & SERVICE

7118 PIONEER AVENUE  
P.O. BOX 380  
AGASSIZ, B.C. V0M 1A0

**Todd Ledoux**  
President

**Doug Halverson**  
Senior Public Affairs Advisor

Westcoast Energy Inc.  
1333 West Georgia Street  
Vancouver, British Columbia  
V6E 3K9  
Telephone (604) 691-5724  
Fax (604) 691-5773



Res. (604) 931-3301





PHONE 796-9055

# Pioneer Motors

Complete Mechanical Repairs, M.V. Inspections,  
Cars, Trucks, Trailers

KEITH HARDY

P.O. Box 167  
Agassiz, B.C. V0M 1A0

"YOUR CHEVRON TOWN PUMP"

## Modern Tire Limited

1756 No. 9 Highway  
Agassiz, B.C. V0M 1A0

Expert Mechanical Repairs  
Inspection Facility

24 Hour Towing Including B.C.A.A. & I.C.B.C.

Air Care Repairs

Telephone: 796-2611



Gordon & Ellen  
Sciotti

# Kent Pastry & Bakery

MARTIN VAN REEUWYK

Internationally Experienced Pastry Chef & Baker

7244 PIONEER AVENUE, BOX 488  
AGASSIZ, B.C. V0M 1A0  
(next to Government Liquor Store)

796-2750

DRYWALL, STUCCO, MASONRY SUPPLIES & TOOLS

# Amigo

 BUILDING SUPPLIES LTD.

MARY DOLL  
CHUCK JARVIS  
HORST STUDENSKY

45840 Rowat Avenue  
Chilliwack, B.C. V2P 1J3  
Tel: (604) 792-8637  
Fax: (604) 792-5153

## Two Pitch Tournament

The following teams have entered this years tournament:

Harvey's Wallbangers  
Buns of Steel  
TRS  
Saanich  
Soowahlie

Katz City Royals  
Traders  
Wolverines  
Seabird  
Distant Drummer

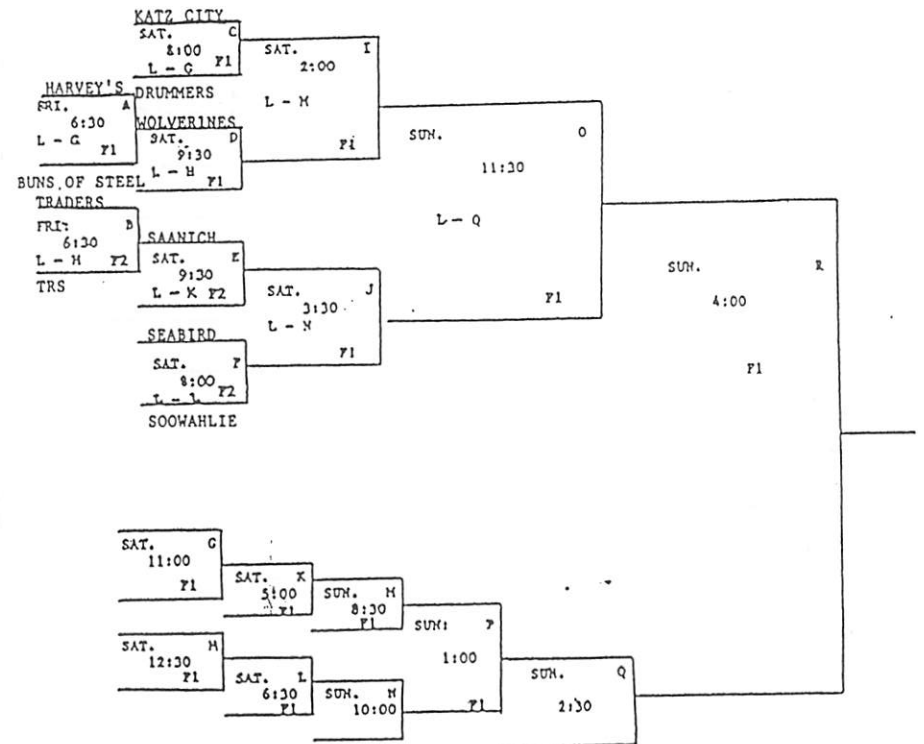

Master of Ceremonies ⇨ Rudy Leon

Judges ⇨ Johnnie Williams Sr.  
Peter Charlie  
Johnnie Williams Jr.

Adam Mussel  
William Charlie  
Jamie Murand

## CANOE SCHEDULE

**Saturday, May 28, 1994**

12:00pm Captains draw for positions,  
races will then follow the draw.

1st   2nd   3rd

	Double Paddle Men	_____
*	Double Paddle Women	_____
	Single Paddle Men	_____
	Mixed Double	_____
	4 Paddle (Women) Small Canoe	_____
	4 Paddle (Men) Small Canoe	_____
	11 Paddle (Women)	_____
	11 Paddle (Men)	_____
**	11 Paddle (Buckskin)	_____

\* Subject to a minimum of 6 entries.  
\*\* ID Required for 16yrs. of age & under.

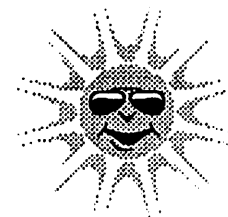

## CANOE SCHEDULE

**Sunday, May 29, 1994**

11:00am Captains draw for positions,  
races will then follow the draw.

1st   2nd   3rd

	Double Paddle (Men)	_____
*	Double Paddle (Women)	_____
	Single Paddle (Men)	_____
	Mixed Double	_____
	6 Paddle (Women) Small Canoe	_____
	6 Paddle (Men) Small Canoe	_____
	11 Paddle (Women)	_____
	11 Paddle (Men)	_____
**	11 Paddle (Buckskin)	_____

Good Luck to All Canoes!